



# BRP RF DESS POSTE Gen3

## Manual de usuario

y

## Certificación/marcado RF por país

### Número de pieza cubierto

Model	BRP	BPP Megatech
CAN	710008832	1001316154
MOWP	515179305	1001316155

### Revisión histórica

Revision	Release date	Details
0	2023-12-18	Original release
1	2026-01-21	Updated certifications for new countries and recertification for Mexico, Brazil.



<b>Sección del manual de usuario</b>	<b>4</b>
EL D.E.S.S. DE RFID DE BRP MANUAL DEL USUARIO	5
<b>Certificación y marcado RF por sección de país</b>	<b>7</b>
1. Argentina	8
2. Australia Certifier body : Braco Compliance Pty Ltd	8
3. New Zealand	8
4. Bahamas	8
5. Brazil	9
6. Canada	9
7. Cayman Islands	10
8. Chile	10
9. China	10
10. Colombia	11
11. Costa Rica	11
12. Curaçao	11
13. Ecuador	11
14. Europe	12
15. Haiti	13
16. Hong Kong	13
17. Indonesia	13
18. Israel	14
19. Japan	14
20. Mexico	15
21. Mongolia	15
22. Panama	15
23. Paraguay	16
24. Peru	16
25. Philippines	16
26. Russia	16
27. Singapore	17
28. South Africa	17
29. South Korea	17
30. Sri Lanka	18
31. Taiwan	18
32. Thailand	19
33. United Kingdom	19
34. United States of America	20



35. Uruguay

21



## Sección del manual de usuario



## EL D.E.S.S. DE RFID DE BRP MANUAL DEL USUARIO

### GENERAL

El D.E.S.S. (sistema de seguridad cifrado digitalmente) de RFID de BRP consta de dos partes, la llave de RFID (que se vende por separado) y el poste de RFID.

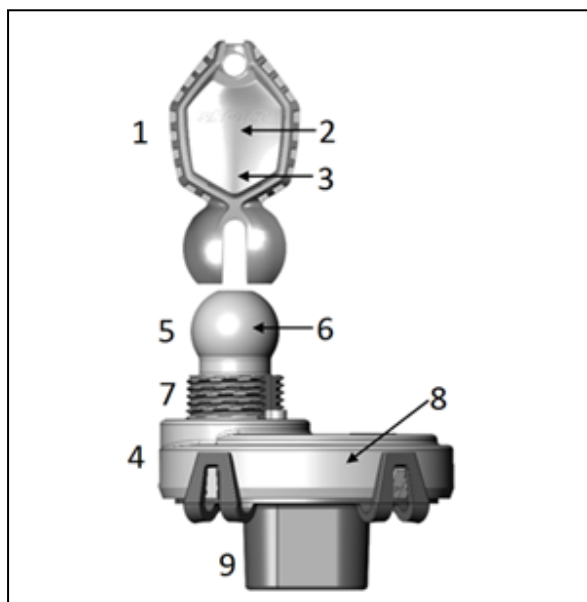

### COMPONENTES

1. Llave de RFID (se vende por separado)
2. Etiqueta interna de RFID de la llave de RFID
3. Imán interno de la llave de RFID
4. Poste de RFID
5. Bola de encaje para fijar la llave de RFID
6. Dispositivo interno de corte de efecto Sala.
7. Enrósquelo para fijar el poste de RFID en la consola del vehículo (número de pieza de la tuerca de plástico a utilizar: 278002963)
8. Antena interna
9. Conector eléctrico

### LEYENDA DE PATILLAS

MODELO DE CAN	
PATILLA	FUNCIÓN
A	Tierra
B	Interruptor de corte
C	CAN bajo
D	Alimentación
E	CAN alto

MODELO DE ONE-WIRE	
PATILLA	FUNCIÓN
A	Tierra
B	Interruptor de corte
C	One-Wire
D	Alimentación

### USO

El poste de RFID se utiliza para:

- Leer el UID de la llave de RFID colocada en el poste y comunicar la información relativa al ECM (Módulo de Control del Motor).
- Mantenga arrancado el vehículo siempre que la llave de RFID esté en el poste de RFID.
- Pare el motor del vehículo si se quita la llave de RFID del poste de RFID.



## FUNCIONAMIENTO BÁSICO

Cuando el usuario intenta arrancar el vehículo, el ECM del vehículo alimenta el poste de RFID. Una vez alimentado, el poste de RFID detecta el imán de la llave de RFID utilizando su sensor de Sala interno. Se cierra la salida del circuito de corte si se detecta un campo magnético, permitiendo que funcione el motor del vehículo. Al mismo tiempo, el poste de RFID activa su lector de RFID, alimentando la llave de RFID y permitiéndole enviar su UID. A

A continuación se transmite un mensaje al ECM a través del enlace de comunicación.

El proceso completo de lectura de la llave se hace normalmente en varias décimas de segundo después de pulsar el botón de arranque.

## ADVERTENCIAS

- El poste de RFID tiene que instalarse solamente en ubicaciones del vehículo designadas por BRP.
- No introduzca nada que contenga piezas metálicas en un radio de 5 cm alrededor de la llave y el poste de RFID mientras se lee la llave.
- No dirija ningún cable que lleve corriente eléctrica en un radio de 5 cm alrededor de la llave y el poste de RFID mientras se lee la llave.
- El poste de RFID únicamente debe utilizarse con llaves de D.E.S.S. de BRP originales.
- El poste de D.E.S.S. de RFID de CAN tiene que emparejarse con el vehículo por parte de un distribuidor autorizado de BRP.

- Un distribuidor autorizado de BRP tiene que programar las llaves de D.E.S.S.
- La antena está integrada en la PCB interna y no se puede sustituir ni modificar. No se puede conectar una antena exterior a este aparato. El circuito de RF únicamente es compatible con la antena interna.
- Los cambios o modificaciones no aprobados expresamente por la parte responsable del cumplimiento podrían anular la autoridad del usuario de utilizar el equipo.

## ESPECIFICACIÓN

ESPECIFICACIÓN	
Temperatura de funcionamiento y almacenamiento del DESS de RFID	-40 °C a +85 °C.
Tensión de funcionamiento	6 a 18 VCC
Número de referencia del modelo de CAN	1001316154
Número de referencia del modelo de Un Hilo	1001316155
Ganancia de la antena	-13.6 dBi

## ASISTENCIA

Para preguntas sobre D.E.S.S. De RFID o algún otro producto BRP, visite:



<https://www.brp.com/en/forms/contact-us.html>



# **Certificación y marcado RF por sección de país**



## 1. Argentina

Certifier body: Comision Nacional de Comunicaciones

	Model Number	BRP Megatech Certificat Number	Certifier body Reference Number
	1001316154	1451022	EX-2023-24353756
	1001316155	1451026	EX-2023-24355833

## 2. Australia Certifier body : Braco Compliance Pty Ltd

	Model Number	BRP Megatech Certificat Number	Certifier body Reference Number
	1001316154	1451006	ACN/ARBN 84156023504
	1001316155		

## 3. New Zealand

	Model Number	BRP Megatech Certificat Number	Certifier body Reference Number
	1001316154	1451007	
	1001316155		

## 4. Bahamas

Certifier body: URCA, Utilites Regulation & Competition Authority of Bahamas

	Model Number	BRP Megatech Certificat Number	Certifier body Reference Number
	1001316154	1451008	URCA_TA_2023_045
	1001316155	1451009	URCA_TA_2023_046



## 5. Brazil



Número: QC-5611-22

BRP Megatech Certificate number : 1450991

Modelo: 1001316154 & 1001316155

Este equipamento não tem direito à proteção contra interferência prejudicial e não pode causar interferência em sistemas devidamente autorizados. Para maiores informações, consulte o site da ANATEL.

## 6. Canada

Industrie Canada : <https://sms-sgs.ic.gc.ca/equipmentSearch/searchRadioEquipments?execution=e1s2>

BRP Megatech document number : 1450975

Certification number / Numéro de certification: 12006A-1001317030

For variant 1001316154 and 1001316155

Certificate number / Numéro de certificat : CER144848

This device complies with part 15 of the FCC Rules. Operation is subject to the following two conditions:

(1) This device may not cause harmful interference, and (2) this device must accept any interference received, including interference that may cause undesired operation.

Changes or modifications not expressly approved by the party responsible for compliance could void the user's authority to operate the equipment.

*This device contains licence-exempt transmitter(s)/receiver(s) that comply with Innovation, Science and Economic Development Canada's licence-exempt RSS(s). Operation is subject to the following two conditions:*

(1) This device may not cause interference.



- (2) This device must accept any interference, including interference that may cause undesired operation of the device.

*L'émetteur/récepteur exempt de licence contenu dans le présent appareil est conforme aux CNR d'Innovation, Sciences et Développement économique Canada applicables aux appareils radio exempts de licence. L'exploitation est autorisée aux deux conditions suivantes :*

- (1) l'appareil ne doit pas produire de brouillage;
- (2) l'appareil doit accepter tout brouillage radioélectrique subi, même si le brouillage est susceptible d'en compromettre le fonctionnement.

Marking : Labelling on the product

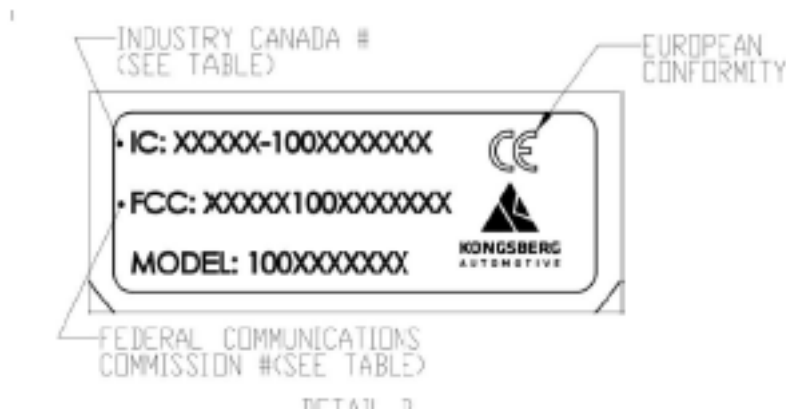

## 7. Cayman Islands

No certification required in Cayman Islands for the devices

## 8. Chile

 Subsecretaría de Telecomunicaciones	Model Number	BRP Megatech Certificat Number	Certifier body Reference Number
	1001316154	1450992	3188 /DO 96.316/F-25
	1001316155	1450993	3189 /DO 96.317/F-25

## 9. China

Investigation and Confirmation Letter of SRRC Product Catalogue



13.56MHz Micro-power Short-Range device is exempted from the current SRRC certification scope.

BRP Megatech's Document ref. 1001277305

## 10. Colombia

Certifier body : Comision de Regulation de comunicaciones

	Model Number	BRP Megatech Certificat Number	Certifier body Reference Number
	1001316154	1451016	2023800337
	1001316155	1451017	2023800339

## 11. Costa Rica

Certifier body : Superintendencia De Telecomunicaciones

	Model Number	BRP Megatech Certificat Number	Certifier body Reference Number
	1001316154	1450980	01233-SUTEL-DGC-2023
	1001316155	1450981	01234-SUTEL-DGC-2023

## 12. Curaçao

Certifier body : The Minister of Traffic,Transportand Urban Planning

	Model Number	BRP Megatech Certificat Number	Certifier body Reference Number
	1001316154	1451012	2023/015/TA
	1001316155	1451013	2023/016/TA

## 13. Ecuador

Certifier body :Agencia de Regulacion y Control de las Telecomunicaciones



	Model Number	BRP Megatech Certificat Number	Certifier body Reference Number
	1001316154	1451018	ARCOTEL-NRH-2023-001463
	1001316155	1451019	ARCOTEL-NRH-2023-001464

## 14. Europe Union, Switzerland & Norway

### Declaration of Conformity

Simplified EU Declaration of Conformity according Radio Equipment Directive 2014/ 53/EU



DE

Hiermit erklärt BRP Megatech, dass der Funkanlagentyp 1001316154 & 1001316155 der Richtlinie 2014/53/EU entspricht. Der vollständige Text der EU-Konformitätserklärung ist unter der folgenden Internetadresse verfügbar:<https://www.brp.com/en/corporate-social-responsibility/product-safety.html>

FR

Le soussigné, BRP Megatech, déclare que l'équipement radioélectrique du type 1001316154 & 1001316155 est conforme à la directive 2014/53/UE. Le texte complet de la déclaration UE de conformité est disponible à l'adresse internet suivante:<https://www.brp.com/en/corporate-social-responsibility/product-safety.html>

BG

C HaCTOflL4OTO BRP Megatech ,QeKnap1pa, 4e TO31 T1n pa,Q1OCbOpb>KeH1e 1001316154 & 1001316155 e B CbOTBeTCTB1e C ,Q1peKT1Ba 2014/53/EC.

L\finOCTH1fIT TeKCT Ha EC ,QeKnapa1.1fITa 3a CbOTBeTCTB1e MO>Ke ,Qa Ce HaMep1 Ha Cne,QH1fl 1HTepHeT a,QpeC:<https://www.brp.com/en/corporate-social-responsibility/product-safety.html>

EL

Mε την παρούσα ο/η BRP Megatech, δηλώνει ότι ο ραδιοεξοπλισμός 1001316154 & 1001316155 πληροί την οδηγία 2014/53/EE. Το πλήρες 1/2 κείμενο της 1/2 δήλωσης 1/2 συμμόρφωσης 1/2 EE διατίθεται στην ακόλουθη ιστοσελίδα στο διαδίκτυο:<https://www.brp.com/en/corporate-social-responsibility/product-safety.html>

CS

Tímto BRP Megatech prohlašuje, že typ rádiového zařízení 1001316154 & 1001316155 je v souladu se směrnicí 2014/53/EU. Úplné znění EU prohlášení o shodě je k dispozici na této internetové adrese:<https://www.brp.com/en/corporate-social-responsibility/product-safety.html>

DA

Hermed erklærer BRP Megatech, at radioudstyrstypen 1001316154 & 1001316155 er i overensstemmelse med direktiv 2014/53/EU.

EU-overensstemmelseserklæringens fulde tekst kan findes på følgende internetadresse:<https://www.brp.com/en/corporate-social-responsibility/product-safety.html>

ET

Käesolevaga deklareerib BRP Megatech, et käesolev raadioseadme tüüp 1001316154 & 1001316155 vastab direktiivi 2014/53/EL nõuetele.

ELi vastavusdeklaratsiooni täielik tekst on kättesaadav järgmisel internetiaadressil:<https://www.brp.com/en/corporate-social-responsibility/product-safety.html>

ES

Por la presente, BRP Megatech declara que el tipo de equipo radioeléctrico 1001316154 & 1001316155 es conforme con la Directiva 2014/53/UE.

El texto completo de la declaración UE de conformidad está disponible en la dirección Internet siguiente:<https://www.brp.com/en/corporate-social-responsibility/product-safety.html>

FI

Manufacturer's name vakuuttaa, että radiolaitetyyppi 1001316154 & 1001316155 on direktiivin 2014/53/EU mukainen.

EU-vaatimustenmukaisuusvakuutuksen täysimittainen teksti on saatavilla seuraavassa internetosoitteessa:<https://www.brp.com/en/corporate-social-responsibility/product-safety.html>

EN

Hereby, BRP Megatech declares that the radio equipment type 1001316154 & 1001316155 is in compliance with Directive 2014/53/EU. The full text of the EU declaration of conformity is available at the following internet address:<https://www.brp.com/en/corporate-social-responsibility/product-safety.html>

HR

BRP Megatech ovime izjavljuje da je radijska oprema tipa 1001316154 & 1001316155 u skladu s Direktivom 2014/53/EU. Cjeloviti tekst EU izjave o sukladnosti dostupan je na sljedećoj internetskoj adresi:<https://www.brp.com/en/corporate-social-responsibility/product-safety.html>

HU

Manufacturer's name igazolja, hogy a 1001316154 & 1001316155 típusú rádióberendezés megfelel a 2014/53/EU irányelvnek. Az

EU-megfelelőségi nyilatkozat teljes szövege elérhető a következő internetes címen:<https://www.brp.com/en/corporate-social-responsibility/product-safety.html>

IT

Il fabbricante, BRP Megatech, dichiara che il tipo di apparecchiatura radio 1001316154 & 1001316155 è conforme alla direttiva 2014/53/UE.



Il testo completo della dichiarazione di conformità UE è disponibile al seguente indirizzo  
Internet:<https://www.brp.com/en/corporate-social-responsibility/product-safety.html>

LT

Aš, BRP Megatech, patvirtinu, kad radijo įrenginių tipas 1001316154 & 1001316155 atitinka Direktyvą 2014/53/ES. Visas ES atitiktis deklaracijos tekstas prieinamas šiuo interneto adresu:<https://www.brp.com/en/corporate-social-responsibility/product-safety.html>

LV

Ar šo BRP Megatech deklarē, ka radioiekārta 1001316154 & 1001316155 atbilst Direktīvai 2014/53/ES. Pilns ES atbilstības deklarācijas teksts ir pieejams šādā interneta vietnē:<https://www.brp.com/en/corporate-social-responsibility/product-safety.html>

MT

B'dan, BRP Megatech, niddikjara li dan it-tip ta' tagħmir tar-radju 1001316154 & 1001316155 huwa konformi mad-Direttiva 2014/53/UE. It-test kollu tad-dikjarazzjoni ta' konformità tal-UE huwa disponibbli f'dan l-indirizz tal-Internet li 9ej:<https://www.brp.com/en/corporate-social-responsibility/product-safety.html>

NL

Hierbij verklaar ik, BRP Megatech, dat het type radioapparatuur 1001316154 & 1001316155 conform is met Richtlijn 2014/53/EU.

De volledige tekst van de EU-conformiteitsverklaring kan worden geraadpleegd op het volgende

internetadres:<https://www.brp.com/en/corporate-social-responsibility/product-safety.html>

PL

BRP Megatech niniejszym oświadcza, że typ urządzenia radiowego 1001316154 & 1001316155 jest zgodny z dyrektywą 2014/53/UE. Pełny tekst deklaracji zgodności UE jest dostępny pod następującym adresem

internetowym:<https://www.brp.com/en/corporate-social-responsibility/product-safety.html>

PT

O(a) abaixo assinado(a) BRP Megatech declara que o presente tipo de equipamento de rádio 1001316154 & 1001316155 está em conformidade com a Diretiva 2014/53/UE.

O texto integral da declaração de conformidade está disponível no seguinte endereço de

Internet:<https://www.brp.com/en/corporate-social-responsibility/product-safety.html>

RO

Prin prezenta, BRP Megatech declară că tipul de echipamente radio 1001316154 & 1001316155 este în conformitate cu Directiva 2014/53/UE.

Textul integral al declaratiei UE de conformitate este disponibil la următoarea adresă

internet:<https://www.brp.com/en/corporate-social-responsibility/product-safety.html>

SV

Härmed försäkrar BRP Megatech att denna typ av radioutrustning 1001316154 & 1001316155 överensstämmer med direktiv 2014/53/EU. Den fullständiga texten till EU-försäkran om överensstämmelse finns på följande

webbadress:<https://www.brp.com/en/corporate-social-responsibility/product-safety.html>

SL

BRP Megatech potrjuje, da je tip radijske opreme 1001316154 & 1001316155 skladen z Direktivo 2014/53/EU. Celotno besedilo izjave EU o

skladnosti je na voljo na naslednjem spletnem naslovu:<https://www.brp.com/en/corporate-social-responsibility/product-safety.html>

SK

BRP Megatech týmto vyhlasuje, že rádiové zariadenie typu 1001316154 & 1001316155 je v súlade so smernicou 2014/53/EÚ. Úplné EÚ

vyhlásenie o zhode je k dispozícii na tejto internetovej adrese:<https://www.brp.com/en/corporate-social-responsibility/product-safety.html>

IS

BRP Megatech lýsir því hér með yfir að þráðlausí fjarskiptabúnaðurinn 1001316154 & 1001316155 er í samræmi við tilskipun 2014/53/ESB.

Óstytta texta ESB-samræmisýfirlýsingarinnar er að finna á

veffanginu:<https://www.brp.com/en/corporate-social-responsibility/product-safety.html>

Liechtenstein

Hiermit erklärt BRP Megatech, dass der Funkanlagentyp 1001316154 & 1001316155 der Richtlinie 2014/53/EU entspricht. Der vollständige Text

der EU-Konformitätserklärung ist unter der folgenden Internetadresse

verfügbar:<https://www.brp.com/en/corporate-social-responsibility/product-safety.html>

NO

Hermed erklærer BRP Megatech at radioutstyrstypen 1001316154 & 1001316155 er i samsvar med direktiv 2014/53/EU. Hele teksten i

EU-samsvarserklæringen finnes på følgende internetadresse:<https://www.brp.com/en/corporate-social-responsibility/product-safety.html>

RU

KoMnaH1fl BRP Megatech HaCTofl41M 3aflBnflE, 4To pa,q1oTexH14eCKoe o6oπy,qoBaH1e KaTerop11 1001316154 & 1001316155 oTBe4aeT

Tpe6oBaH1flM .Q1peKT1B1 2014/53/EU.

nonH111 TeKCT ,qeKnapa1.11 CooTBeTCTB1fl EC ,qoCTyneH Ha

Ca11Tehttps://www.brp.com/en/corporate-social-responsibility/product-safety.html

## 15. Haiti

Certifier Body: Conseil National des telecommunication

	Model Number	BRP Megatech Certificat Number	Haiti Reference Number
	1001316154	1451010	CNT-H-RC 0003270
	1001316155	1451011	CNT-H-RC 0003249



## 16. Hong Kong

Certifier Body: Nemko

	Model Number	BRP Megatech Certificat Number	Nemko Reference Number
	1001316154	1450999	CA0012300012
	1001316155	1451000	CA0012300014

## 17. Indonesia

Certification suspended, information missing

## 18. Israel

Certifier body: Ministry of Communications

Compliant with FCC 47 CFR Part 15, subpart B

BRP Megatech Industries Inc. : יצרן  
 1001316154 : דגם  
 משדר-מקלט : סוג ציוד

הספק (וואט)	תחום תדרים (מה"ץ)	
0.000001	13.5600	13.5600

BRP Megatech Industries Inc. : יצרן  
 1001316155 : דגם  
 משדר-מקלט : סוג ציוד

הספק (וואט)	תחום תדרים (מה"ץ)	
0.000001	13.5600	13.5600

	Model Number	BRP Megatech Certificat Number	Certifier body Reference Number
	1001316154	1450996	51-92634
	1001316155	1450997	51-74761



## 19. Japan

Model Number	BRP Megatech Certificat Number	Certifier body Reference Number
1001316154	1451003	AC-23066
1001316155		

## 20. Mexico



IFETEL

Marca: BRP Megatech

Número: BRME1023-28186

BRP Megatech Certificate number : 1450978

Modelo: 1001316154 & 1001316155

NOM-208-SCFI-2016 (Disposición Técnica IFT-008-2015)

La operación de este equipo está sujeta a las siguientes dos condiciones:

21. Es posible que este equipo o dispositivo no cause interferencia perjudicial y
22. Este equipo o dispositivo debe aceptar cualquier interferencia, incluyendo la que pueda causar su operación no deseada.

### **Dictamen de IFETEL:**

“La operación de este equipo está sujeta a las siguientes dos condiciones: (1) es posible que este equipo o dispositivo no cause interferencia perjudicial y (2) este equipo o dispositivo debe aceptar cualquier interferencia, incluyendo la que pueda causar su operación no deseada.”

## 23. Mongolia

Certifier Body: Communications Regulatory commission of Mongolia



	Model Number	BRP Megatech Certificat Number	Certifier Body Reference Number
	1001316154 1001316155	1451027	A23000877

## 24. Panama

Certifier Body: Republica de Panama, Autoridad Nacional de Los Publicos

Model Number	BRP Megatech Certificat Number	Certifier Body Reference Number
1001316154	1451014	5789
1001316155	1451015	5790

## 25. Paraguay

Certifier Body: Conatel Comision Nacional de Telecomunicaciones

	Model Number	BRP Megatech Certificat Number	Certifier Body Reference Number
	1001316154	1451020	2023-01-I-0064
	1001316155	1451021	2023-01-I-0065

## 26. Peru

Certifier Body: Ministerio de Transportes y Comunicaciones

Exemption : No es exigible la homologaciones para este equipo

Model Number	BRP Megatech Certificat Number	Certifier Body Reference Number
1001316154	1450984	T-059452-2023
1001316155	1450985	T-059472-2023



## 27. Philippines

Certifier Body: Republic of the Philippines National Telecommunications Commission

	Model Number	BRP Megatech Certificat Number	Certifier Body Reference Number
	1001316154	1451030	ESD-RCE-2332130
	1001316155	1451031	ESD-RCE-2332131

## 28. Singapore

Certifier Body: Infocomm Media Development Authority

	Model Number	BRP Megatech Certificat Number	Certifier Body Reference Number
	1001316154	1451032	Complies with IMDA Standards N6010-22
	1001316155	1451033	Complies with IMDA Standards N6011-22

## 29. South Africa

Certifier Body: Certifier Body: Independent Communications Authority of South Africa

	Model Number	BRP Megatech Certificat Number	Certifier Body Reference Number
	1001316154 1001316155	1450998	TA-2023/0228

Label must be on the packaging, exporter have to request labels to BRP Megatech Canada +1(873) 208-5757



### 30. South Korea

7991-C5E3-868B-0D43

<b>방송통신기자재등의 적합등록 필증</b> <i>Registration of Broadcasting and Communication Equipments</i>	
상호 또는 성명 Trade Name or Registrant	BRP Megatech Industries Inc.
기자재명칭(제품명칭) Equipment Name	Dess Post RFID Gen3
기기부호/추가 기기부호 Equipment code /Additional Equipment code	RFID3
기본모델명 Basic Model	1001316154
파생모델명 Series Model	1001316155
등록번호 Registration No.	R-R-BmI-1001316154
제조사/제조국가 Manufacturer/Country of	BRP Megatech Industries Inc./캐나다
등록연월일 Date of Registration	2023-04-26
기타 Others	
<p>위 기자재는 「전파법」 제58조의2 제3항에 따라 등록되었음을 증명합니다.            It is verified that foregoing equipment has been registered under the Clause 3, Article 58-2 of Radio Waves Act.</p> <p style="text-align: right;">2023년(Year) 04월(Month) 26일(Day)</p> <p style="text-align: center;">국립전파연구원장              Director General of National Radio Research Agency</p> <p style="color: red; font-size: small;">※ 적합등록 방송통신기자재는 반드시 "적합성평가표시" 를 부착하여 유통하여야 합니다.            위반시 과태료 처분 및 등록이 취소될 수 있습니다.</p>	



## 31. Sri Lanka

Certifier Body: Telecommunication Regulatory Commission of Sri Lanka

	Model Number	BRP Megatech Certificat Number	Certifier Body Reference Number
	1001316154	1451004	TRC/SM/TA /0041/23-0195
	1001316155	1451005	TRC/SM/TA/0041/23-0196

## 32. Taiwan

Certifier Body: Nemko

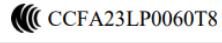
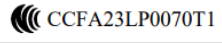
	Model Number	BRP Megatech Certificat Number	Nemko Reference Number
	1001316154	1451001	
	1001316155	1451002	

### Statement

The following text “Without permission granted by the NCC, any company, enterprise, or user is not allowed to change frequency, enhance transmitting power or alter original characteristic as well as performance to a approved low power radio-frequency devices. The low power radio-frequency devices shall not influence aircraft security and interfere legal communications; If found, the user shall cease operating immediately until no interference is achieved. The said legal communications means radio communications is operated in compliance with the Telecommunications Management Act. The low power radio-frequency devices must be susceptible with the interference from legal communications or ISM radio wave radiated devices.”

取得審驗證明之低功率射頻器材，非經核准，公司、商號或使用者均不得擅自變更頻率、加大功率或變更原設計之特性及功能。低功率射頻器材之使用不得影響飛航安全及干擾合法通信；經發現有干擾現象時，應立即停用，並改善至無干擾時方得繼續使用。前述合法通信，指依電信管理法規定作業之無線電通信。低功率射頻器材須忍受合法通信或工業、科學及醫療用電波輻射性電機設備之干擾。

The certified CTRF shall not change the frequency, increase the power or change the RF characteristics and functions of the original design without permission. The utility of the certified CTRF must not affect flight safety and interfere with legitimate communications. If interference is found, it should be



immediately deactivated and improved until no interference is found. The legitimate communications in the preceding paragraph refers to radio communication operating in accordance with the provisions of the Telecommunications Act. The CTRF must withstand interference from legitimate communications or radio equipment for industrial, scientific, and medical applications

以取得審驗證明之射頻模組(組件)組裝於最終產品後，取得審驗證明者，應於該最終產品輸入、販賣或公開陳列前，檢具 標註最終產品廠牌、型號及外觀照片之電子檔，向原驗證機關（構）登錄；以射頻模組（組件）取得審驗證明者，授權他人使用其審驗合格標籤，該射頻模組（組件）組裝於最終產品後，取得審驗證明者應檢具標註最終產品廠牌、型號及外觀 照片之電子檔，向原驗證機關（構）登錄。

### 33. Thailand

Certifier Body: Office of the National Broadcasting and Telecommunications Commission

	Model Number	BRP Megatech Certificat Number	Certifier Body Reference Number
	1001316154	1451028	SD00336-23
	1001316155	1451029	SD00414-23

### 34. United States of America

BPR Megatech’s Document : 1450976

FCC : <https://fccid.io/2ACER1001317030>

Certification number / Numéro de certification: 2ACER 1001317030

For variant 1001316154 and 1001316155.

This device complies with part 15 of the FCC Rules. Operation is subject to the following two conditions:

(1) This device may not cause harmful interference, and (2) this device must accept any interference received, including interference that may cause undesired operation.

Changes or modifications not expressly approved by the party responsible for compliance could void the user's authority to operate the equipment.



*This device contains licence-exempt transmitter(s)/receiver(s) that comply with Innovation, Science and Economic Development Canada’s licence-exempt RSS(s). Operation is subject to the following two conditions:*

- (1) This device may not cause interference.
- (2) This device must accept any interference, including interference that may cause undesired operation of the device.

Marking : Labelling on the product

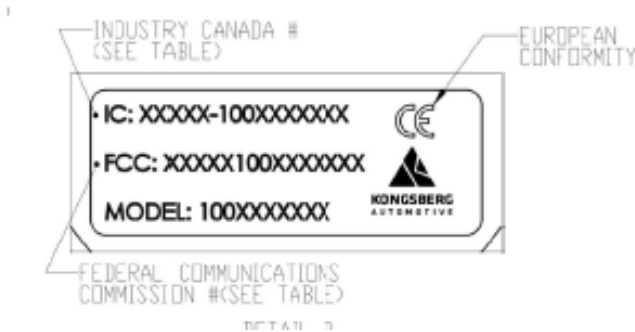

### 35. Uruguay

Certifier Body :URSEC (Unidad Reguladora de Servicios de Comunicaciones)

	Model Number	BRP Megatech Certificat Number	Nemko Reference Number
	1001316154	1450994	VU20200814-009689
	1001316155	1450995	VU20200814-009692

### 36. United Arab Emirates

 ER42847/25 United Arab Emirates	Model Number	BRP Megatech Certificat Number	Nemko Reference Number
	1001316155	TIC-D01-CS01	ER42847/25



### 37. Madagascar

	Model Number	BRP Megatech Certificat Number	Nemko Reference Number
	1001316154		N' 241319-DCP/ARTEC/DG /DNCSR/SNAESR/test
	1001316155		N' 2413 18-DCP/ARTEC/DG/DN CSR/SNAESR/test

### 38. Barhain

 هيئة تنظيم الاتصالات Kingdom of Bahrain - مملكة البحرين	Model Number	Application reference	Nemko Reference Number
	1001316154	SD/932/852	SD/SRD/2025/852/1
	1001316155	SD/932/853	SD/SRD/2025/853/1